

# The Holographic Dual of

$$AdS_3 \times S^3 \times S^3 \times S^1$$

David Tong

Based on arXiv:1402.5135

# Supergravity Solution

$$AdS_3 \times \mathbf{S}_+^3 \times \mathbf{S}_-^3 \times \mathbf{S}^1$$

Supported by fluxes  $Q_5^\pm$  and  $Q_1$

Elitzur, Feinerman, Giveon and Tsabar (1998)  
de Boer and Skenderis (1999)  
Gukov, Martinec, Moore and Strominger (2004)

# Large N=4 Superalgebra

R-symmetry:

$$SO(4)^- \times SO(4)^+ \cong SU(2)_L^- \times SU(2)_R^- \times SU(2)_L^+ \times SU(2)_R^+$$

- There are two  $SU(2)$  current algebras.
- There is also a  $U(1)$  coming from  $S^1$  factor of the geometry.

Elitzur, Feinerman, Giveon and Tsabar (1998)  
de Boer and Skenderis (1999)  
Gukov, Martinec, Moore and Strominger (2004)

# Central Charge

$AdS_3 \times S^3_+ \times S^3_- \times S^1$  supported by fluxes  $Q_5^\pm$  and  $Q_1$

$$c = 6Q_1 \frac{Q_5^+ Q_5^-}{Q_5^+ + Q_5^-}$$

# How to Build the Boundary Field Theory

# A Tantalising D-Brane Configuration

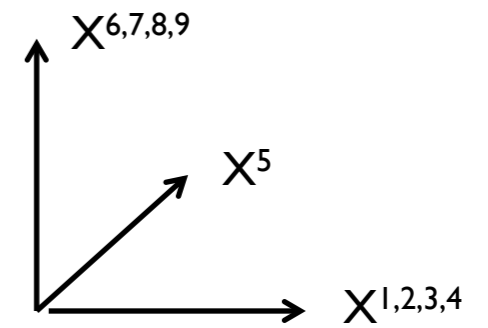
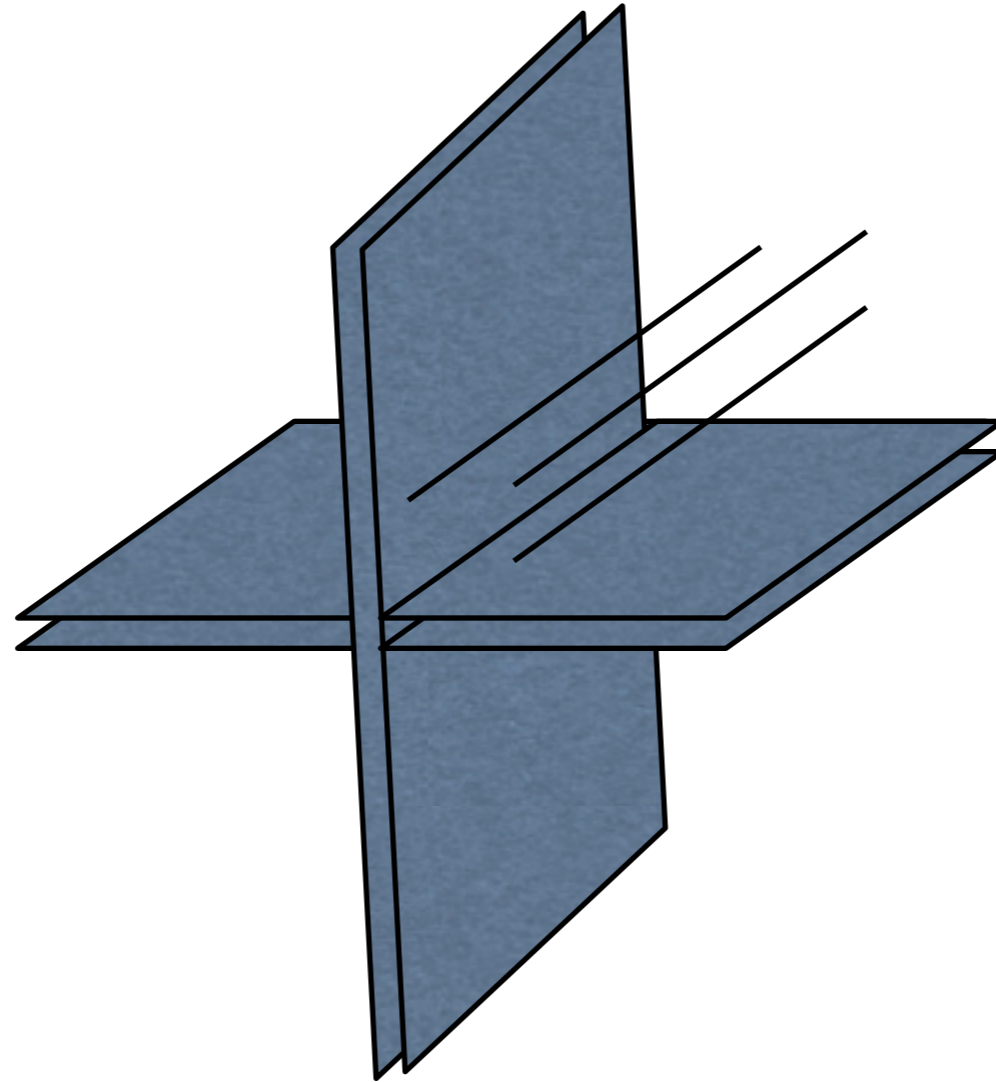

$Q_5^+$  D5-branes: 012345  
 $Q_5^-$  D5'-branes: 056789  
 $Q_1$  D1-branes: 05

# Taking the Near Horizon Limit

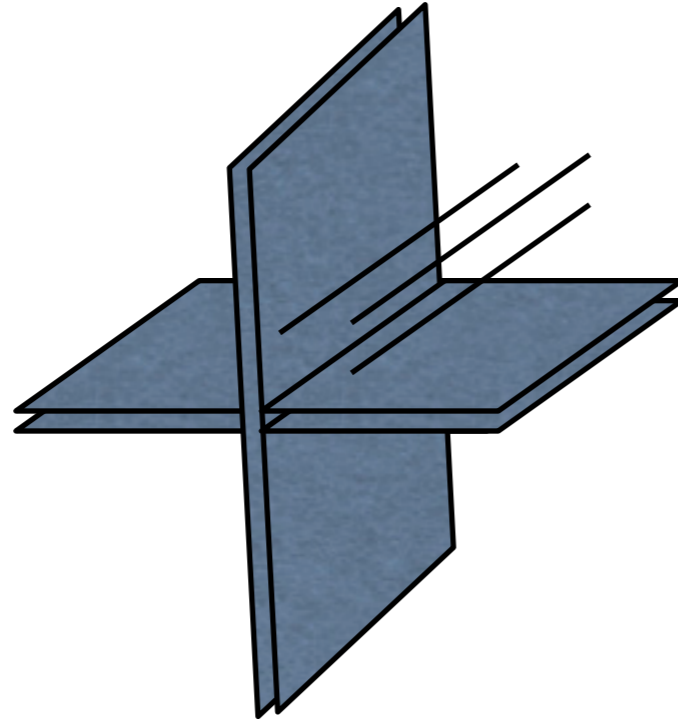

$Q_5^+$  D5-branes: 012345  
 $Q_5^-$  D5'-branes: 056789  
 $Q_1$  D1-branes: 05

Smear D1-branes along 1234 and 6789. The near horizon limit is:

$$AdS_3 \times \mathbf{S}_+^3 \times \mathbf{S}_-^3 \times \mathbf{R}$$

How should we interpret this?!

Basic Idea: Study this D-brane configuration anyway!

# The Low-Energy Dynamics of D-Branes

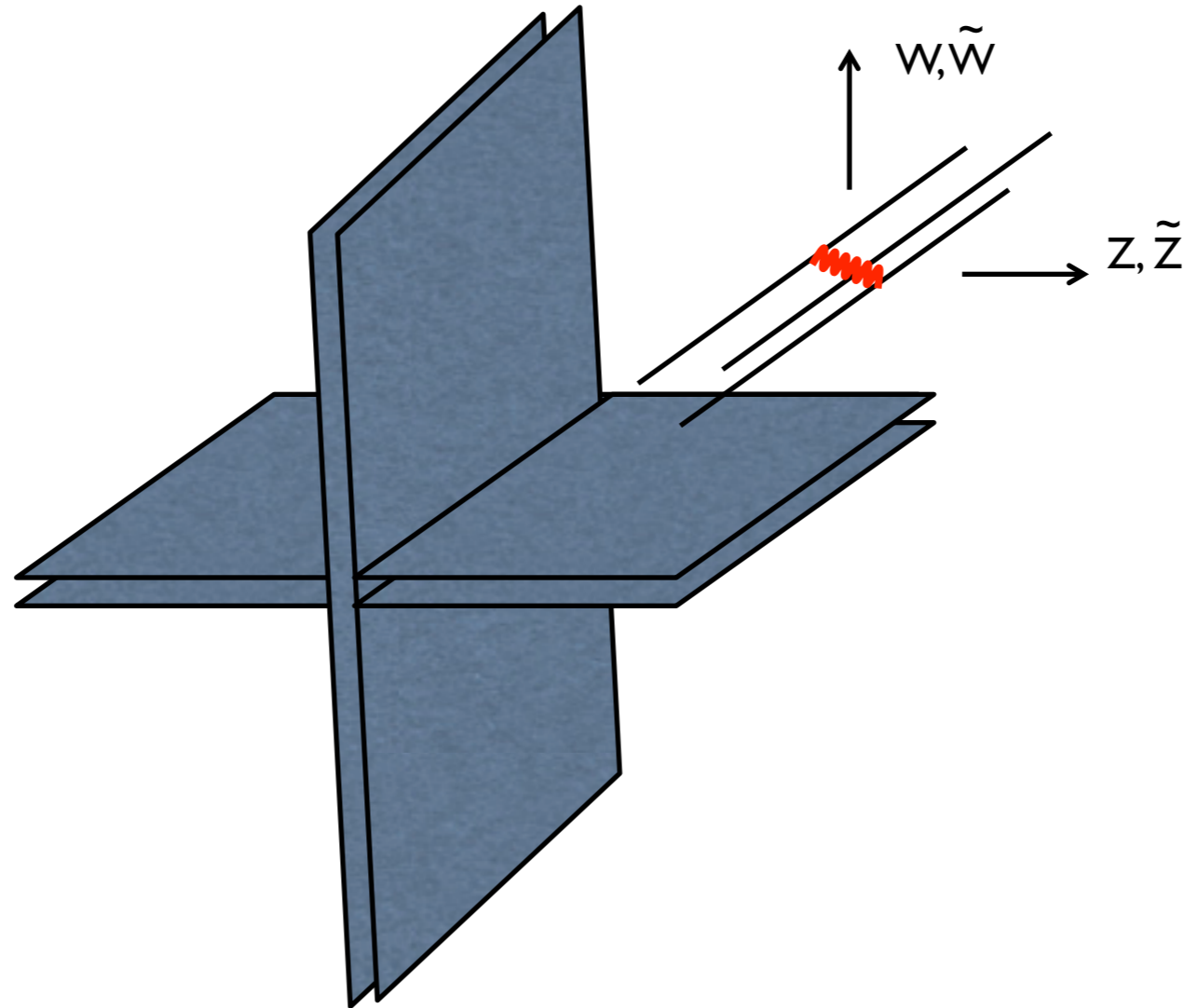

$Q_5^+$  D5-branes: 012345  
 $Q_5^-$  D5'-branes: 056789  
 $Q_1$  D1-branes: 05

D1-D1 strings:  $U(Q_1)$  vector multiplet

- $N=(8,8)$  supersymmetry
- Gauge field and four complex, adjoint scalars



# The Low-Energy Dynamics of D-Branes

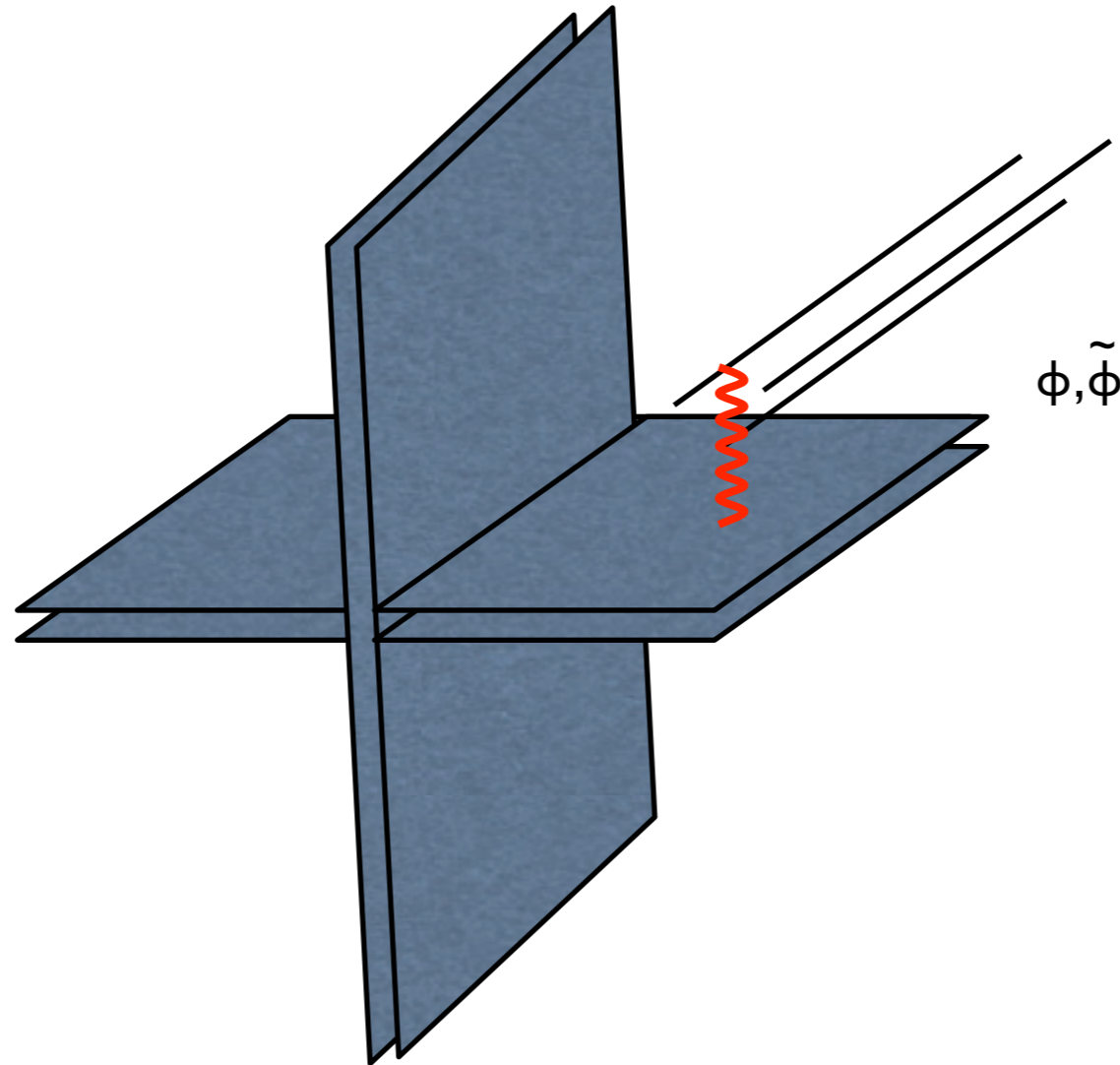

$Q_5^+$  D5-branes: 012345  
 $Q_5^-$  D5'-branes: 056789  
 $Q_1$  D1-branes: 05

D1-D5 strings:  $Q_5^+$  fundamental hypermultiplets

- $N=(4,4)$  supersymmetry
- two complex fundamental scalars

# The Low-Energy Dynamics of D-Branes

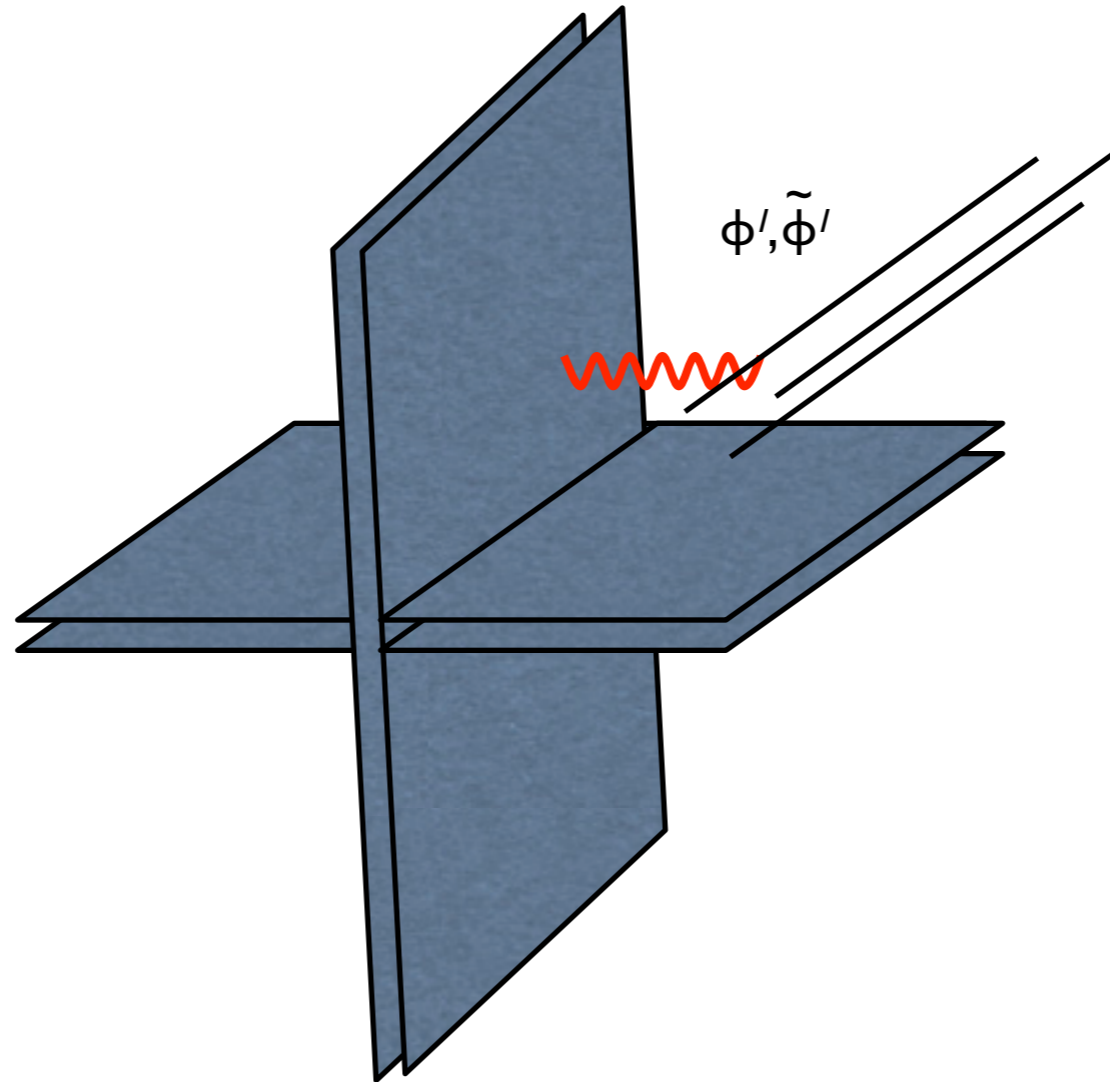

$Q_5^+$  D5-branes: 012345  
 $Q_5^-$  D5<sup>l</sup>-branes: 056789  
 $Q_1$  D1-branes: 05

D1-D5<sup>l</sup> strings:  $Q_5^-$  fundamental (twisted) hypermultiplets

- $N=(4,4)$  supersymmetry (but a different one!)
- two complex fundamental scalars

# The Low-Energy Dynamics of D-Branes

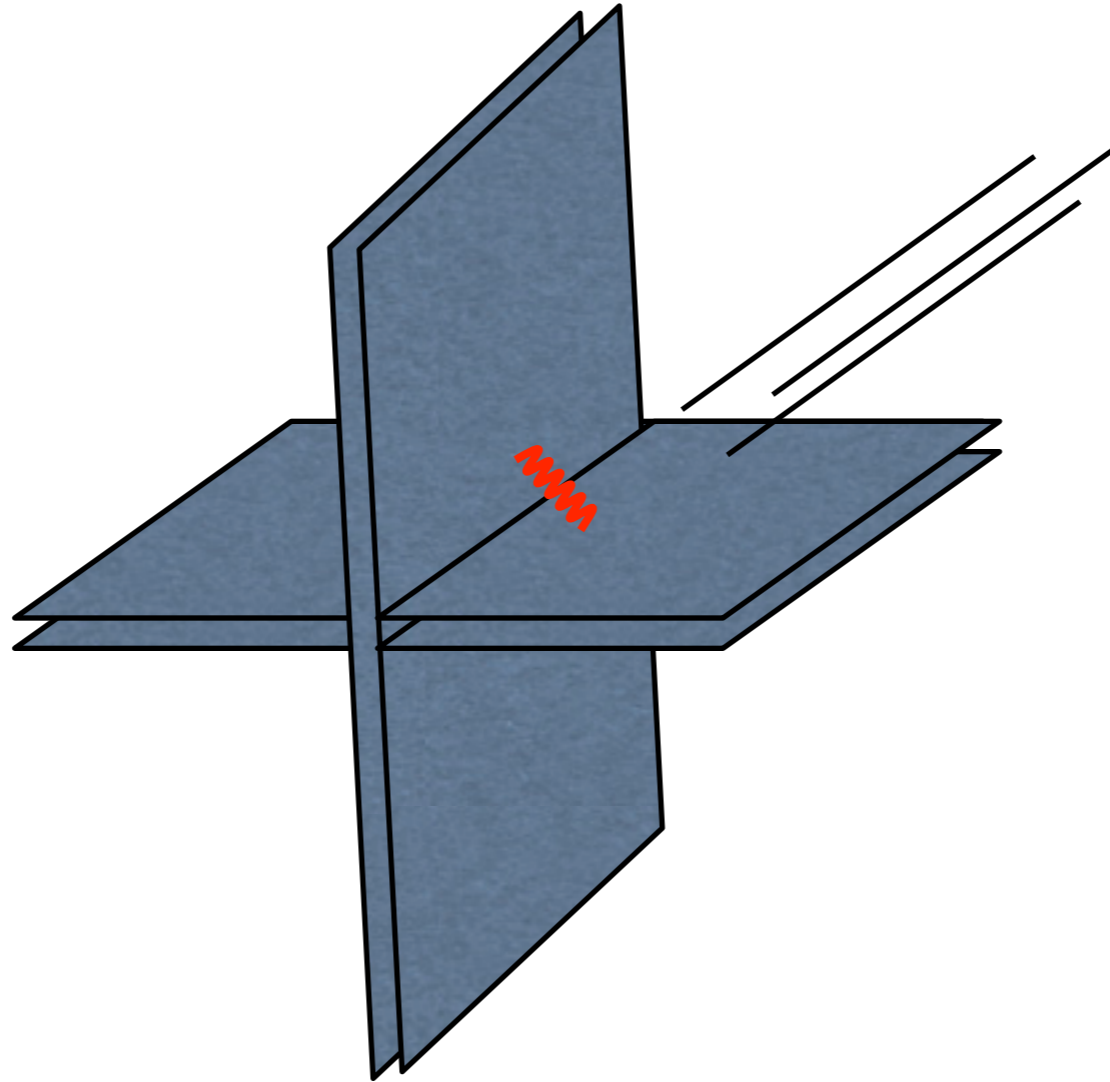

$Q_5^+$  D5-branes: 012345  
 $Q_5^-$  D5'-branes: 056789  
 $Q_1$  D1-branes: 05

D5-D5' strings:  $Q_5^+ Q_5^-$  Fermi multiplets

- $N=(0,8)$  supersymmetry
- only left-moving fermions

# The Low-Energy Dynamics of D-Branes

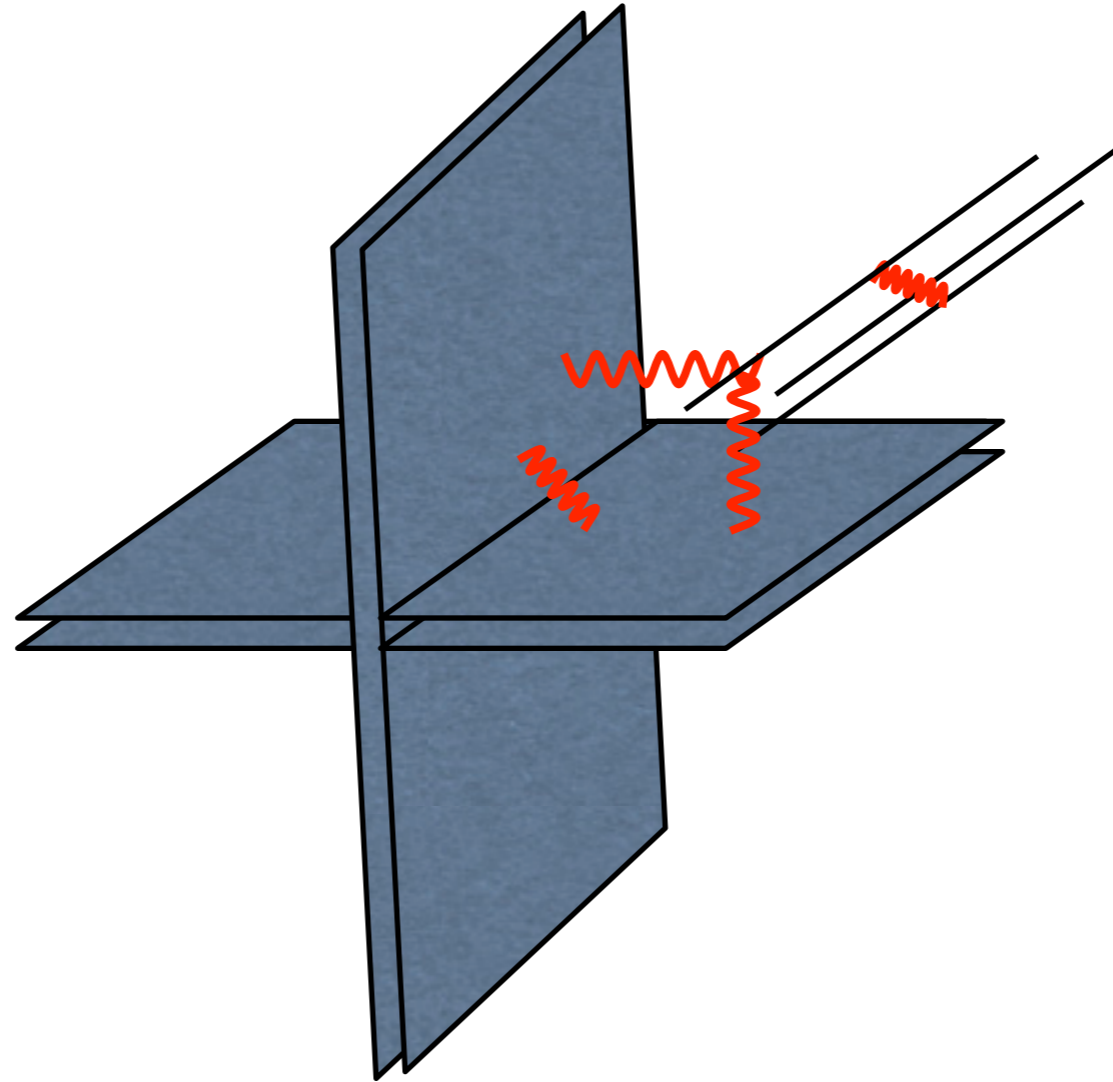

- All branes together preserve  $N=(0,4)$  supersymmetry
- The only question: how do chiral fermions couple to the other fields?
  - Surprising answer: the coupling is fixed by supersymmetry

# A Brief Explanation of Supersymmetry

Use  $N=(0,2)$  superfields. Scalar potential terms are built using Fermi multiplets.

$$\Psi = \psi_- - \theta^+ G - i\theta^+ \bar{\theta}^+ (D_0 + D_1)\psi_- - \bar{\theta}^+ E(\phi_i) + \theta^+ \bar{\theta}^+ \frac{\partial E}{\partial \phi^i} \psi_{+i}$$

E-Terms

$$\bar{D}_+ \Psi_a = E_a(\Phi_i)$$

Holomorphic functions of chiral superfields

J-Terms

$$S_J = \int d^2x d\theta^+ \sum_a \Psi_a J^a(\Phi_i) + \text{h.c.}$$

The scalar potential is:

$$V = \sum_a |E_a|^2 + |J_a|^2 + D^2$$

But there is only  $N=(0,2)$  supersymmetry if:  $E \cdot J \equiv \sum_a E_a J^a = 0.$

# The Coupling of the Chiral Fermions

The D5-D5' strings are needed to ensure that  $EJ=0$

$$E_\chi = -\frac{1}{2}\tilde{\Phi}\Phi'$$

$$J_\chi = \frac{1}{2}\tilde{\Phi}'\Phi$$

$$E_{\tilde{\chi}} = -\frac{1}{2}\tilde{\Phi}'\Phi$$

$$J_{\tilde{\chi}} = \frac{1}{2}\tilde{\Phi}\Phi'$$

# $N=(0,4)$ $U(Q_1)$ Gauge Theory

- $Q_5^+$  fundamental hypermultiplets
- $Q_5^-$  fundamental twisted hypermultiplets
- $Q_5^+ Q_5^-$  neutral Fermi multiplets

Flavour symmetry:  $SU(Q_5^+) \times SU(Q_5^-)$

Also:  $SO(4)^- \times SO(4)^+ \cong SU(2)_L^- \times SU(2)_R^- \times SU(2)_L^+ \times SU(2)_R^+$

$(Z, \tilde{Z})$  in  $(2,2)$



$(Y, \tilde{Y})$  in  $(2,2)$



These are  $N=(0,4)$  R-symmetries



Finally, the theory has a global flavour symmetry which rotates hypers, twisted hypers and Fermi multiplets

# The Scalar Potential

To write it in a way in which the symmetries are manifest, define:

$$\omega = \begin{pmatrix} \phi \\ \tilde{\phi}^\dagger \end{pmatrix} \quad \omega' = \begin{pmatrix} \phi' \\ \tilde{\phi}'^\dagger \end{pmatrix}$$

and

$$\vec{D}_Z = \vec{\eta}_{ij} Z^i Z^j + \omega^\dagger \vec{\sigma} \omega$$

↖
↖
↖
↖

In **3** of  $SU(2)_R^+$ 
In **3** of  $SU(2)_R^-$ 
Self-dual 't Hooft matrices
Pauli matrices

$$V = \text{Tr} (\vec{D}_Z \cdot \vec{D}_Z + \vec{D}_Y \cdot \vec{D}_Y) + \omega^\dagger Y^i Y^i \omega + \omega'^\dagger Z^i Z^i \omega' + \text{Tr} [Y^i, Z^j]^2 + \text{Tr} (\omega^\dagger \cdot \omega \omega'^\dagger \cdot \omega')$$

$$\text{last term} = \sum_{a=1}^{Q_5^+} \sum_{b=1}^{Q_5^-} \left( (\phi_a^\dagger \phi_b') (\phi_b'^\dagger \phi_a) + (\tilde{\phi}_a \tilde{\phi}_b'^\dagger) (\tilde{\phi}_b' \tilde{\phi}_a^\dagger) + (\phi_a^\dagger \tilde{\phi}_b'^\dagger) (\tilde{\phi}_b' \phi_a) + (\tilde{\phi}_a \phi_b') (\phi_b'^\dagger \tilde{\phi}_a^\dagger) \right)$$



# Vacuum Moduli Space

$$V = \text{Tr} (\vec{D}_Z \cdot \vec{D}_Z + \vec{D}_Y \cdot \vec{D}_Y) + \omega^\dagger Y^i Y^i \omega + \omega'^\dagger Z^i Z^i \omega' + \text{Tr} [Y^i, Z^j]^2 + \text{Tr} (\omega^\dagger \cdot \omega \omega'^\dagger \cdot \omega')$$

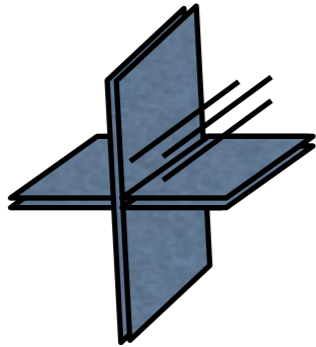

- $\omega = \omega' = 0$  with  $Z^i$  and  $Y^i$  mutually commuting.

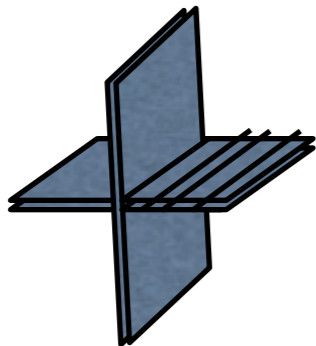

- $\vec{D}_Z = 0$  and  $Y^i = \omega' = 0$

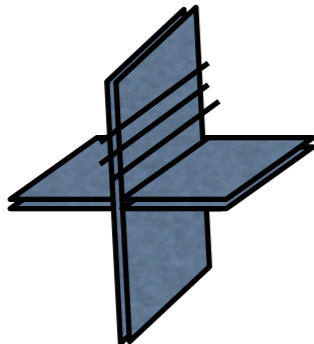

- $\vec{D}_Y = 0$  and  $Z^i = \omega = 0$

But in fact, we'll be interested in modes which appear to localise at the origin...

Flowing to the Infra-Red

# Computing the Central Charge of $N=(0,2)$ Theories

The OPE of the right-moving R-current includes the term

$$R(x)R(y) \sim \frac{3c_R}{(x^- - y^-)^2} + \dots$$

But this is the anomaly. Which means that the central charge can be computed in the ultra-violet

$$c_R = 3\text{Tr } R^2$$

Sum over right-moving fermions, minus left-moving fermions

# Computing the Central Charge of $N=(0,2)$ Theories

$$c_R = 3\text{Tr } R^2$$

There's one small catch: you have to identify the right R-current in the UV. The requirement is:

$$\text{Tr } F R = 0$$

Silverstein and Witten (1993)

Any  $U(1)$  global symmetry  $F$



This can be repackaged as “c-extremization”

Benini and Bobev (2012)  
Adams, Tong and Wecht  
(Stupidly unpublished)

# Computing the Central Charge of $N=(0,4)$ Theories

Right-moving R-current is:  $SU(2)_R^- \times SU(2)_R^+$

- No mixing for non-Abelian symmetries
- But  $N=(0,2)$  R-current is some combination of

$$R^\pm \subset su(2)_R^\pm$$

Both are good  $N=(0,2)$  R-currents. But there is one combination that is an  $N=(0,2)$  flavour symmetry

$$U = R^+ - R^-$$

We must have

$$\text{Tr } UR = 0$$

$$\begin{array}{l} \text{Tr } UR^- = -2Q_1 Q_5^- \\ \text{Tr } UR^+ = +2Q_1 Q_5^+ \end{array} \quad \Rightarrow \quad R = \frac{Q_5^+}{Q_5^+ + Q_5^-} R^- + \frac{Q_5^-}{Q_5^+ + Q_5^-} R^+$$

# Computing the Central Charge of $N=(0,4)$ Theories

$$c_R = 3\text{Tr } R^2 \quad \Rightarrow$$

$$c = 6Q_1 \frac{Q_5^+ Q_5^-}{Q_5^+ + Q_5^-}$$

In agreement with the result from supergravity

# Other Anomalies

- Each SU(2) symmetry in the gauge theory has an anomaly.
- These agree with the levels of the large  $N=4$  algebra

$$\text{Tr} (R^+)^2 = \text{Tr} (L^+)^2 = Q_1 Q_5^+ \quad \text{SU(2)}_R^+ \text{ and SU(2)}_L^+$$

$$\text{Tr} (R^-)^2 = \text{Tr} (L^-)^2 = Q_1 Q_5^- \quad \text{SU(2)}_R^- \text{ and SU(2)}_L^-$$

# Other Anomalies

But....

- There is no symmetry corresponding to the  $S^1$  action of the geometry.
- The gauge theory has more degrees of freedom.
  - These show up in the  $SU(Q_5^+)$  and  $SU(Q_5^-)$  flavour symmetries

$$\text{Tr} (F^+)^2 = Q_5^- \quad \text{Tr} (F^-)^2 = Q_5^+$$

and the left-moving central charge

$$c_L = c_R + 2Q_5^+ Q_5^-$$



# Proposal

$N=(0,4)$  Gauge Theory

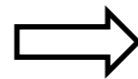

Large  $N=4$  CFT dual to  $\text{AdS}_3 \times \text{S}^3 \times \text{S}^3 \times \text{S}^1$   
+ decoupled left-moving fermions

# Where does this CFT live?

Right-moving R-symmetries cannot act on scalars in asymptotic (semi-classical) parts of moduli space. But...

$$R[Y] = R[\tilde{Y}] = \frac{Q_5^-}{Q_5^+ + Q_5^-} \quad R[Z] = R[\tilde{Z}] = \frac{Q_5^+}{Q_5^+ + Q_5^-}$$

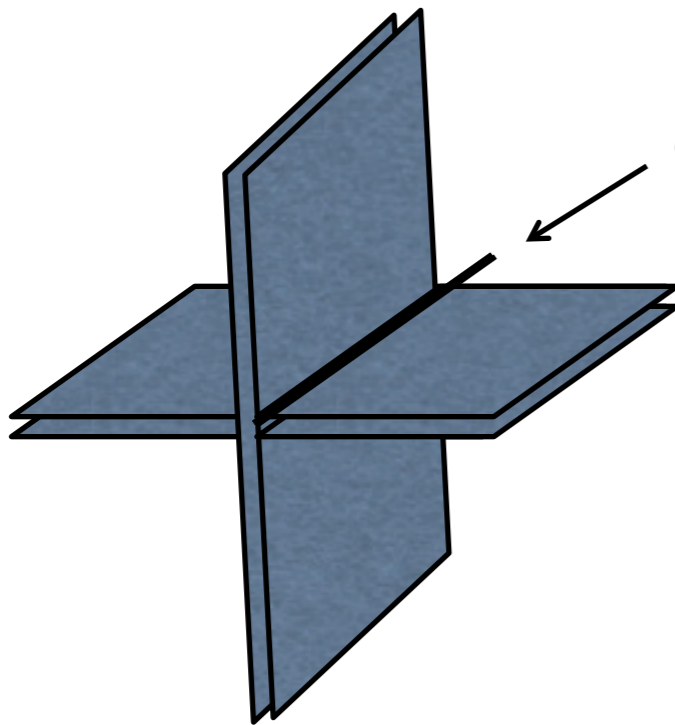

CFT degrees of freedom are localised at the origin.

- This is surprising in  $d=1+1$  (Mermin-Wagner theorem)
- But related things happen in  $N=(4,4)$ 
  - Decoupling of Higgs and Coulomb branches

# What happened to the Chiral Modes?

An interesting story was found in the absence of D1-branes. This configuration is called the *I-brane*

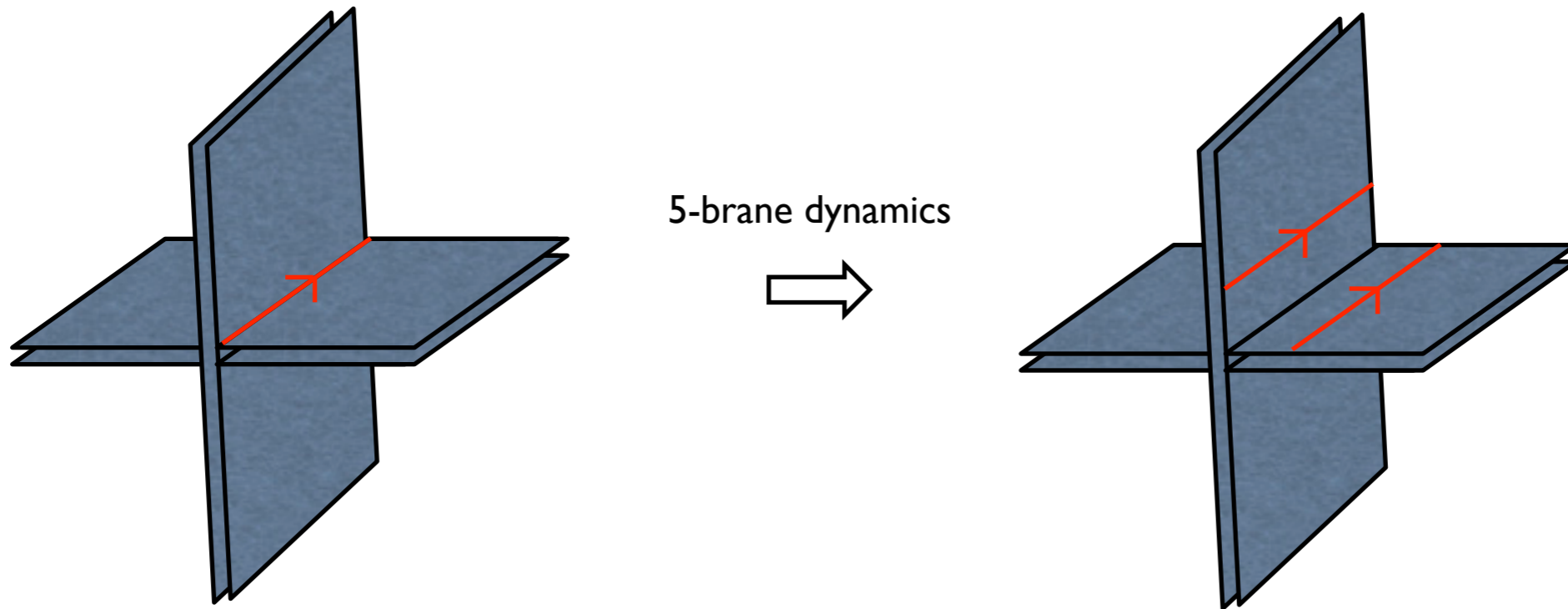

- Chiral modes are pushed away from the intersection.
- The intersection has a mass gap
- It also has  $d=2+1$  dimensional symmetry!

# Decoupling in d=1+1 U(1) Theory

An (old) idea: Integrate out hypermultiplets. Focus on DI-DI fields Y and Z

$$\begin{aligned}
 ds^2 &= \left( \frac{1}{g^2} + \frac{Q_5^+}{y^2} \right) (dy^2 + y^2 (d\Omega_3^+)^2) + \left( \frac{1}{g^2} + \frac{Q_5^-}{z^2} \right) (dz^2 + z^2 (d\Omega_3^-)^2) \\
 &\rightarrow Q_5^+ \left( \frac{dy^2}{y^2} + (d\Omega_3^+)^2 \right) + Q_5^- \left( \frac{dz^2}{z^2} + (d\Omega_3^-)^2 \right)
 \end{aligned}$$

Aharony and Berkooz (1999)

The chiral fermions survive this integrating out.

$$\mathcal{L}_{\text{chiral}} = \left( 1 + \frac{\log(y^2/z^2)}{y^2 - z^2} \right) \bar{\chi}_- \partial_+ \chi_- + \dots$$

$$\frac{\log(y^2/z^2)}{y^2 - z^2} \rightarrow \begin{cases} \log y & y \rightarrow 0 \\ \frac{1}{y^2} & y = z \rightarrow 0 \end{cases}$$

We can show that the right number of chiral fermions decouple. But...



Work with Ofer and Kenny Wong

# Summary

$N=(0,4)$  Gauge Theory

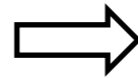

Large  $N=4$  CFT dual to  $\text{AdS}_3 \times S^3 \times S^3 \times S^1$   
+ decoupled left-moving fermions

- What works:
  - central charge
  - level of  $SU(2)$  currents
  - decoupling of chiral fermions for  $U(1)$  theory
- What doesn't (yet):
  - decoupling of chiral fermions in general
    - (and non-chiral interactions)
  - emergence of  $U(1)$  symmetry associated to  $S^1$ 
    - (and associated marginal operator)

Thank you for your attention

# The Algebra

$$G^a(z)G^b(w) = \frac{2c}{3} \frac{\delta^{ab}}{(z-w)^3} - \frac{8\gamma\alpha_{ab}^{+,i}A^{+,i}(w) + 8(1-\gamma)\alpha_{ab}^{-,i}A^{-,i}(w)}{(z-w)^2} - \frac{4\gamma\alpha_{ab}^{+,i}\partial A^{+,i}(w) + 4(1-\gamma)\alpha_{ab}^{-,i}\partial A^{-,i}(w)}{z-w} + \frac{2\delta^{ab}L(w)}{z-w} + \dots,$$

$$A^{\pm,i}(z)A^{\pm,j}(w) = -\frac{k^{\pm}\delta^{ij}}{2(z-w)^2} + \frac{\epsilon^{ijk}A^{\pm,k}(w)}{z-w} + \dots,$$

$$Q^a(z)Q^b(w) = -\frac{(k^+ + k^-)\delta^{ab}}{2(z-w)} + \dots,$$

$$U(z)U(w) = -\frac{k^+ + k^-}{2(z-w)^2} + \dots,$$

$$A^{\pm,i}(z)G^a(w) = \mp \frac{2k^{\pm}\alpha_{ab}^{\pm,i}Q^b(w)}{(k^+ + k^-)(z-w)^2} + \frac{\alpha_{ab}^{\pm,i}G^b(w)}{z-w} + \dots,$$

$$A^{\pm,i}(z)Q^a(w) = \frac{\alpha_{ab}^{\pm,i}Q^b(w)}{z-w} + \dots,$$

$$Q^a(z)G^b(w) = \frac{2\alpha_{ab}^{+,i}A^{+,i}(w) - 2\alpha_{ab}^{-,i}A^{-,i}(w)}{z-w} + \frac{\delta^{ab}U(w)}{z-w} + \dots,$$

$$U(z)G^a(w) = \frac{Q^a(w)}{(z-w)^2} + \dots$$

# BPS Bound

$AdS_3 \times S^3_+ \times S^3_- \times S^1$  supported by fluxes  $Q_5^\pm$  and  $Q_1$

$$h = \frac{Q_5^-}{Q_5^- + Q_5^+} l^+ + \frac{Q_5^+}{Q_5^- + Q_5^+} l^- + \frac{1}{Q_1(Q_5^+ + Q_5^-)} [(l^+ - l^-)^2 + u^2]$$

Representation under  $SU(2)^{+/-}$

Charge under  $U(1)$

- The bound is non-linear.
  - There is no chiral ring!
- The non-linearities are “1/N” suppressed.
  - They are not seen in supergravity